

Geostationary Lightning Mapper Observations and Applications

Dr. Scott Rudlosky – NOAA/NESDIS/STAR
STAR Seminar Series (15 November 2018)

<https://vlab.ncep.noaa.gov/web/geostationary-lightning-mapper/>



Geostationary Lightning Mapper

- **GOES GLM provides continuous total lightning measurements (to 54° N/S)**
- **Observes both intra-cloud (IC) and cloud-to-ground (CG) lightning, does not distinguish between them**
- **New instrument undergoing an extended calibration and validation**
- **GOES team worked alongside the instrument vendor to reach beta (June 2017), provisional (January 2018), and full (November 2018) maturity status**

Performance Requirements

Full disk coverage

Detection efficiency > 70%, averaged over full disk and 24 h

Flash false alarm rate shall be less than 5%, averaged over 24 hours

Navigation error within ± 112 microradians (~1/2 pixel or ~4 km)

Dynamic range greater than 100 at all times everywhere in FOV

GLM Applications

- The GLM detects electrically active storms and the areal lightning extent
- Allows forecasters to track embedded convective cells, identify strengthening and weakening storms, monitor convective mode and storm evolution, characterize storms as they transition offshore, gain insights into tropical cyclone intensity changes

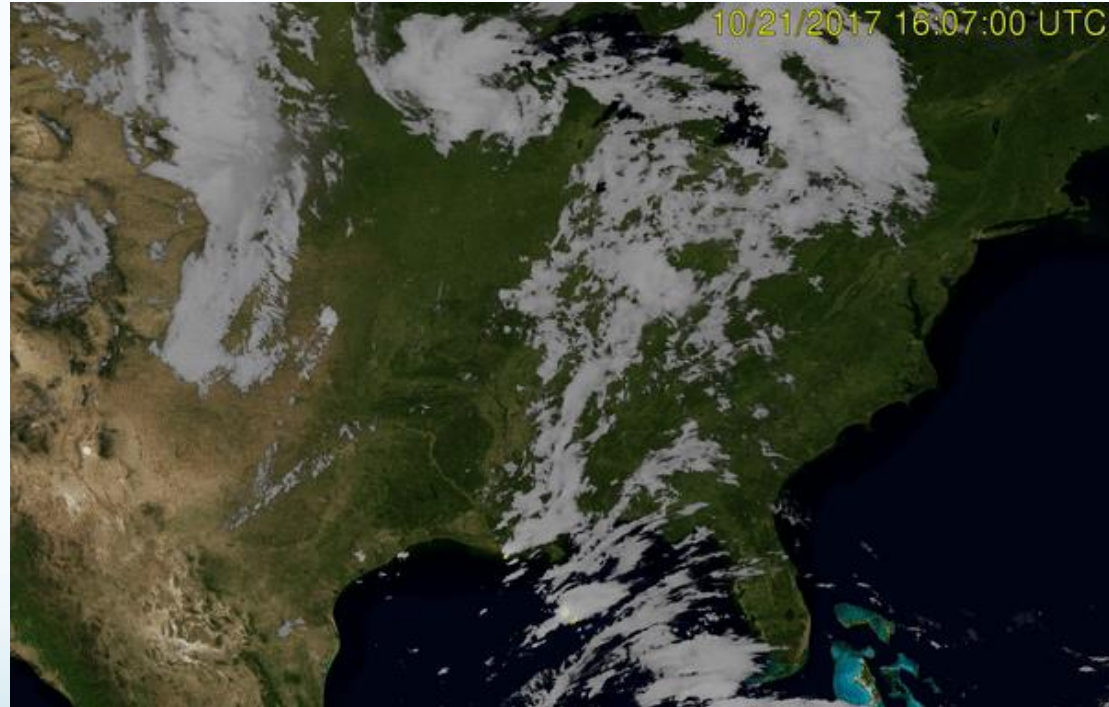

GLM Detection Methods

- GLM creates background images every 2.5 min
- Detects changes in brightness relative to the background every ~2 ms
- Illuminated pixels are termed GLM Events
- Filters determine the likelihood that events are real lightning
- Lightning Cluster Filter Algorithm combines events into groups and groups into flashes (definitions on next slide)

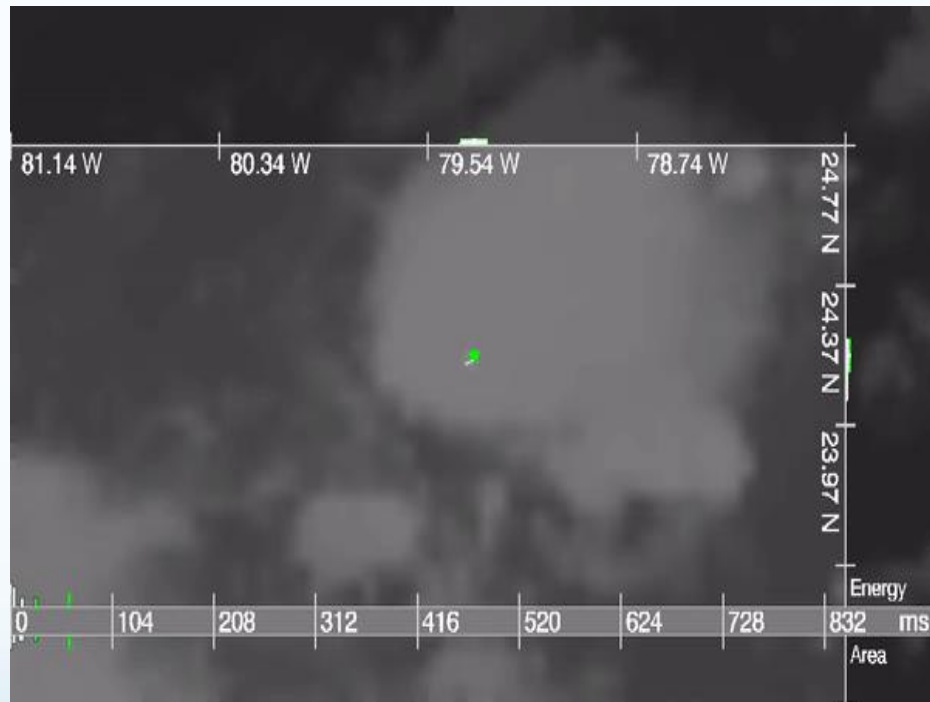

GLM Definitions

- **Event**: occurrence of a single pixel exceeding the detection threshold during one ~ 2 ms frame
 - **Group**: one or more simultaneous GLM events observed in adjacent (neighboring/diagonal) pixels
 - **Flash**: 1 or more sequential groups separated by less than 330 ms and 16.5 km
- **GLM Flash rates are most closely tied to updraft and storm evolution, and GLM Event locations best depict the spatial extent**

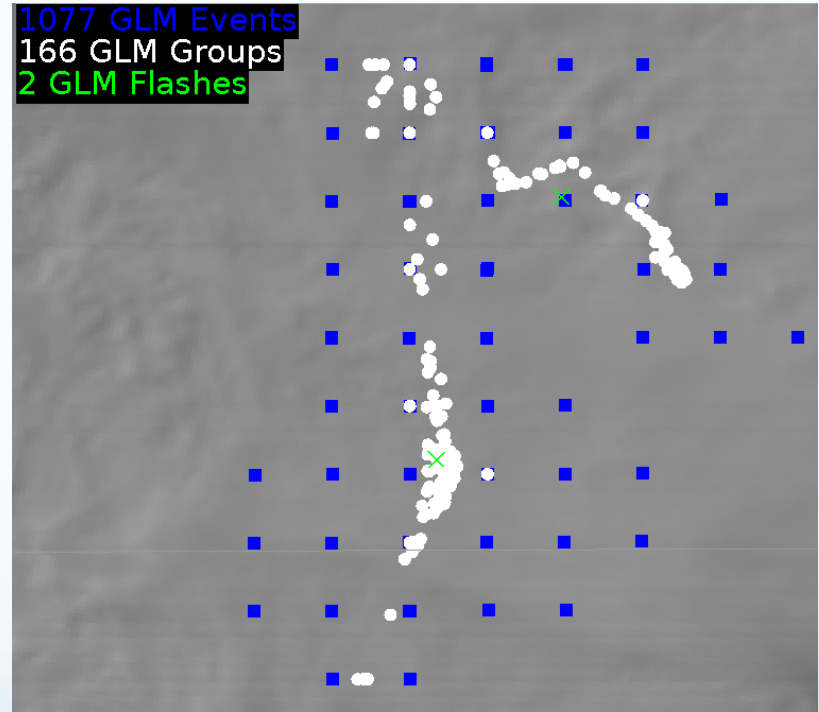

Event, Group, and Flash Locations

- Radiance is recorded for each illuminated pixel (Event)
- Group/Flash locations are radiance-weighted centroids that consider all constituent Events/Groups
- Flash location (black X) represents radiance contributions from all events in both groups and may not always fall along the relatively narrow lightning channel

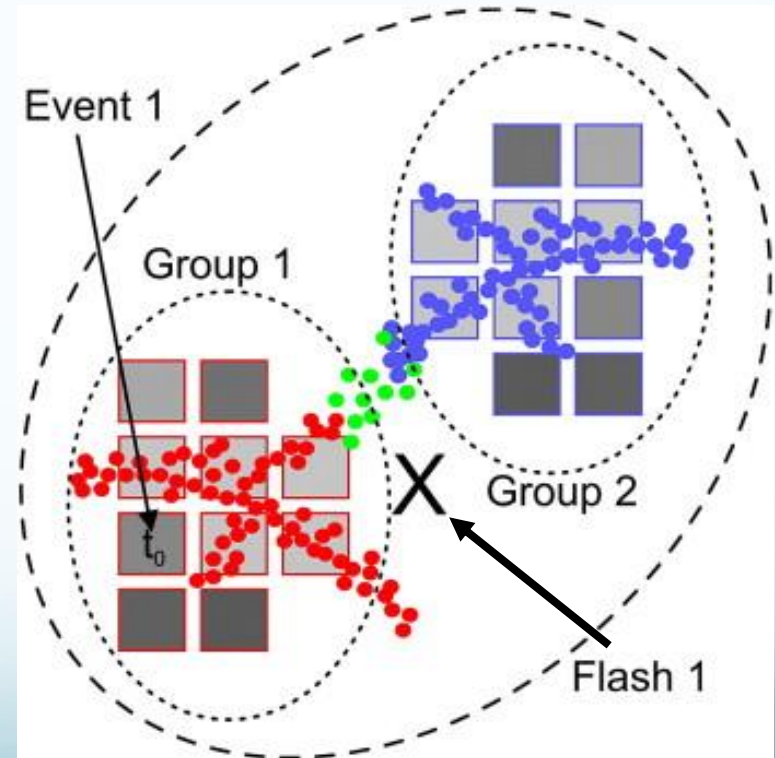

Observing Individual Flashes

- GLM maps the extent of the cloud illuminated by individual flashes
- Despite a relatively coarse spatial resolution, the GLM provides rapid temporal updates, allowing it to map flash structure
- Groups are used to create flash skeletons
- Optical lightning observations provide helpful insights into the flash structure
- Can be used to make inferences regarding lightning physics and storm structure

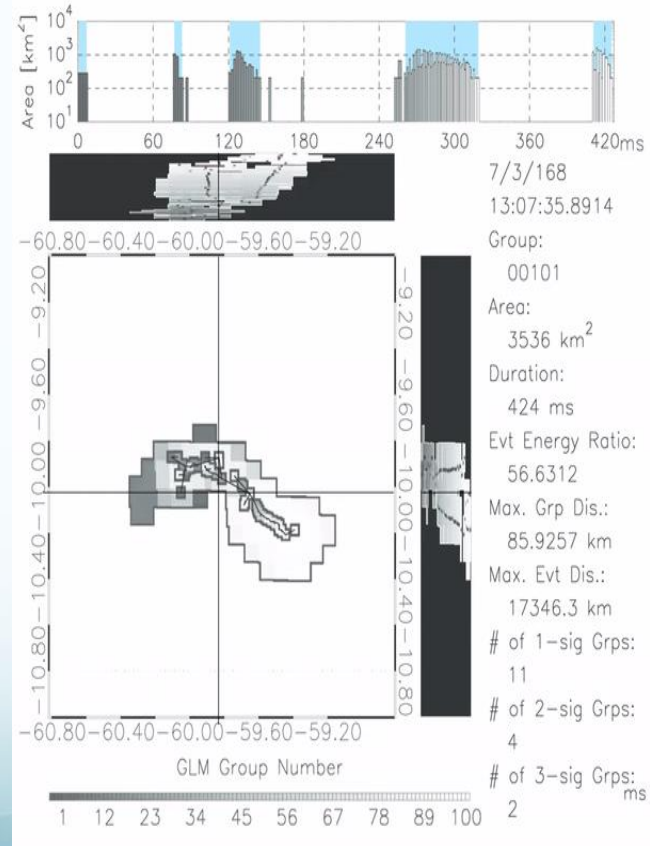

Observing Many Flashes

- Observing individual flashes clearly illustrates that the GLM is an imager rather than a detector
- Lightning composition and time-evolution provides insights into convective mode and storm structure
- Scientists are working to quantify this information to develop products that aid forecasters (e.g., gridded GLM products)



First Recap

- **GLM provides continuous, full disk total lightning measurements**
- **Filters determine the likelihood that events are real lightning**
- **LCFA combines events into groups and groups into flashes**
- **Flash rates are most closely tied to updraft and storm evolution**
- **Event locations best depict the spatial lightning extent**
- **Group/Flash locations are radiance-weighted centroids**
- **Rapid temporal updates allow the GLM to map the flash structure**
- **Provides insights regarding lightning physics and storm structure**

Initial GLM Distributions

- Initial nine months of observations from the GOES-East position (Dec 2017 – Aug 2018)

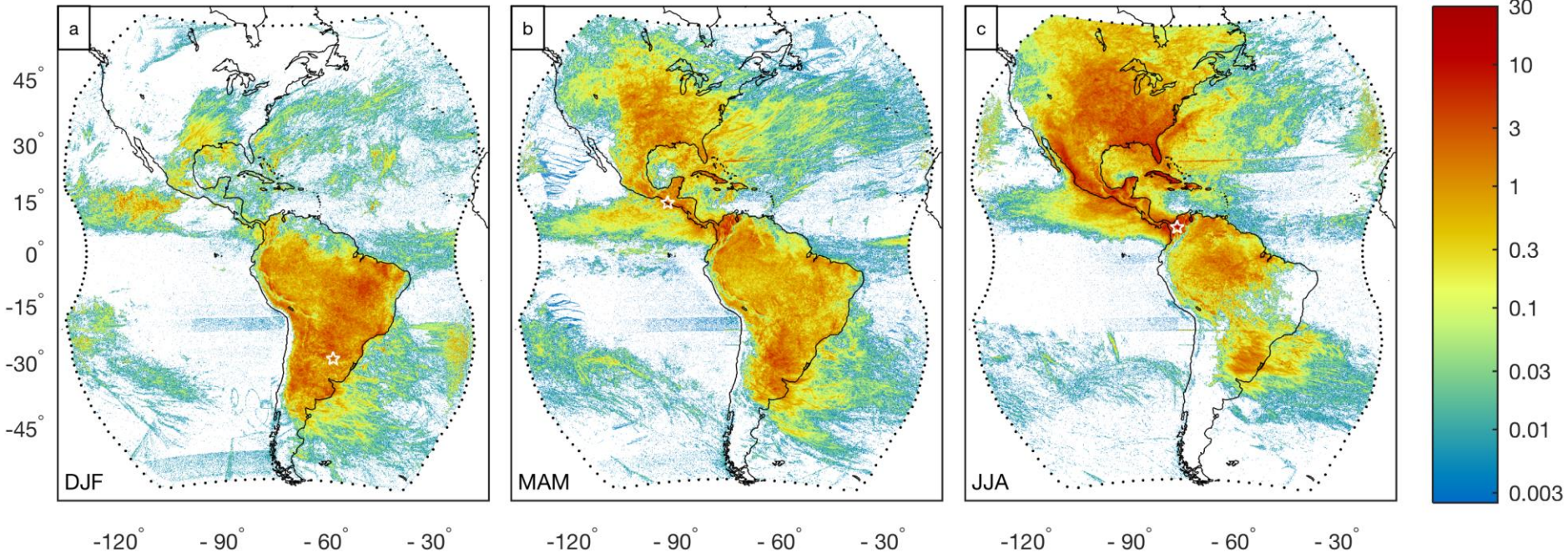

- Rudlosky, S. D., S. J. Goodman, K. S. Virts, and E. C. Bruning (2018), Initial Geostationary Lightning Mapper Observations, *Geophys. Res. Lett.*, Under review

Overall Distributions

- Initial GLM results confirm similar spatial patterns of lightning occurrence found in previous studies over much longer time periods
- The average Lightning Imaging Sensor (LIS) flash (313 km²; Beirle et al. 2014) was ~69% the size of the average GLM flash (454 km²)
- Larger GLM flashes are likely due in part to the larger GLM pixels

Overall	Mean	Median	90th	99th
Flash Area (km ²)	454	291	965	2570
Flash Duration (ms)	301	240	626	1170
Flash Energy (fJ)	261	90	658	2390
Groups per Flash (count)	16.4	10.0	40.0	83.0
Events per Flash (count)	42.2	22.0	106.0	267.0
Events per Group (count)	2.6	2.0	5.0	14.0
Group Area (km ²)	180	135	350	1010
Group Energy (fJ)	16.2	6.1	33.6	153.0
Event Energy (fJ)	6.2	3.1	12.2	48.8

Land versus Ocean Contrast

- On average, GLM flashes over the oceans are larger (570 km²), longer duration (345 ms), and brighter (420 fJ) than flashes over land (431 km², 293 ms, 230 fJ)

Mean Values	All	Land	Ocean	Difference (%)
Flash Area (km ²)	454	431	570	30.6
Flash Duration (ms)	301	293	345	17.3
Flash Energy (fJ)	261	230	420	72.8
Groups per Flash (count)	16.4	15.4	21.3	36.0
Events per Flash (count)	42.2	39.3	57.0	41.9

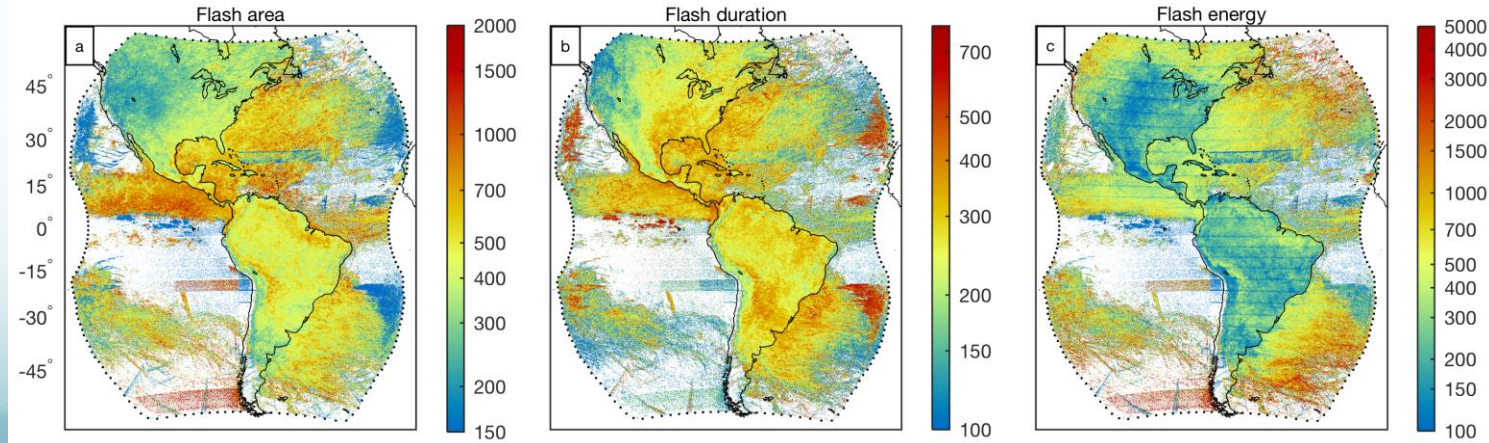

Beyond GLM Flash Counts

- Data quality artifacts are much more apparent in plots of the other GLM characteristics
- In addition to investigating long time series of lightning properties, these additional GLM parameters can help diagnose data quality in real time

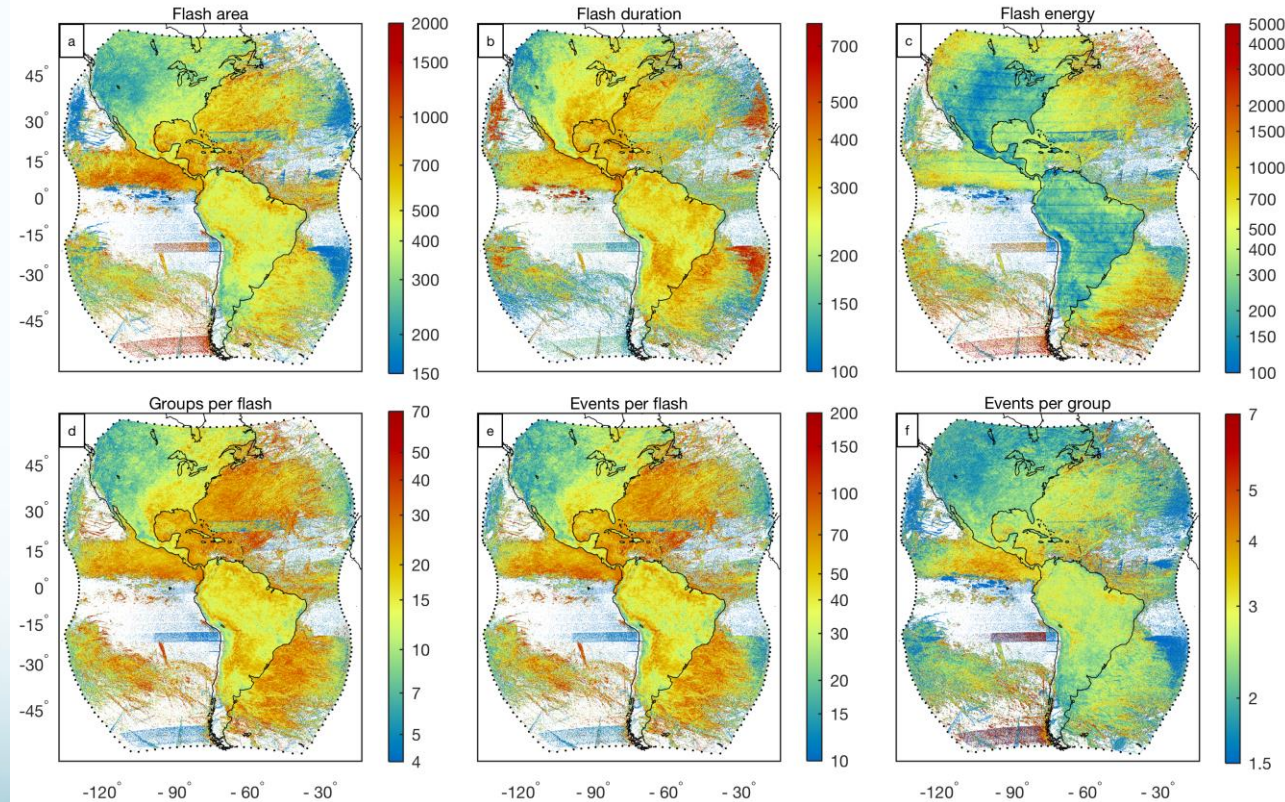

Lake Maracaibo Diurnal Cycle

- An innovative aspect of the GLM is the ability to continuously sample lightning distributions at every location within its near-hemispheric field of view
- LIS could require up to 35 years to sample the diurnal cycle for the equivalent of the 257 days (~9 months) studied here

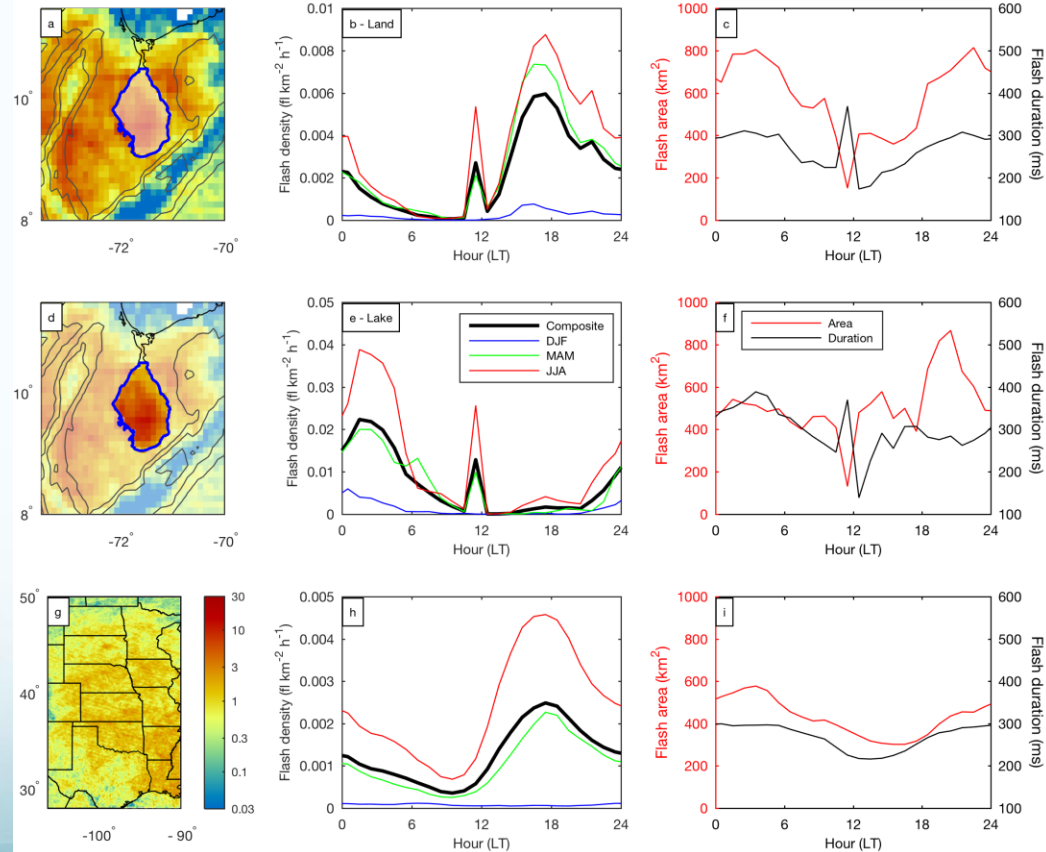

Lake Maracaibo Diurnal Cycle

- Over the land areas surrounding Lake Maracaibo, daytime heating of the elevated terrain produced a late-afternoon lightning frequency maximum
- Greatest flash densities in the Lake Maracaibo domain occurred over the lake during a nocturnal peak at ~2:00 LT

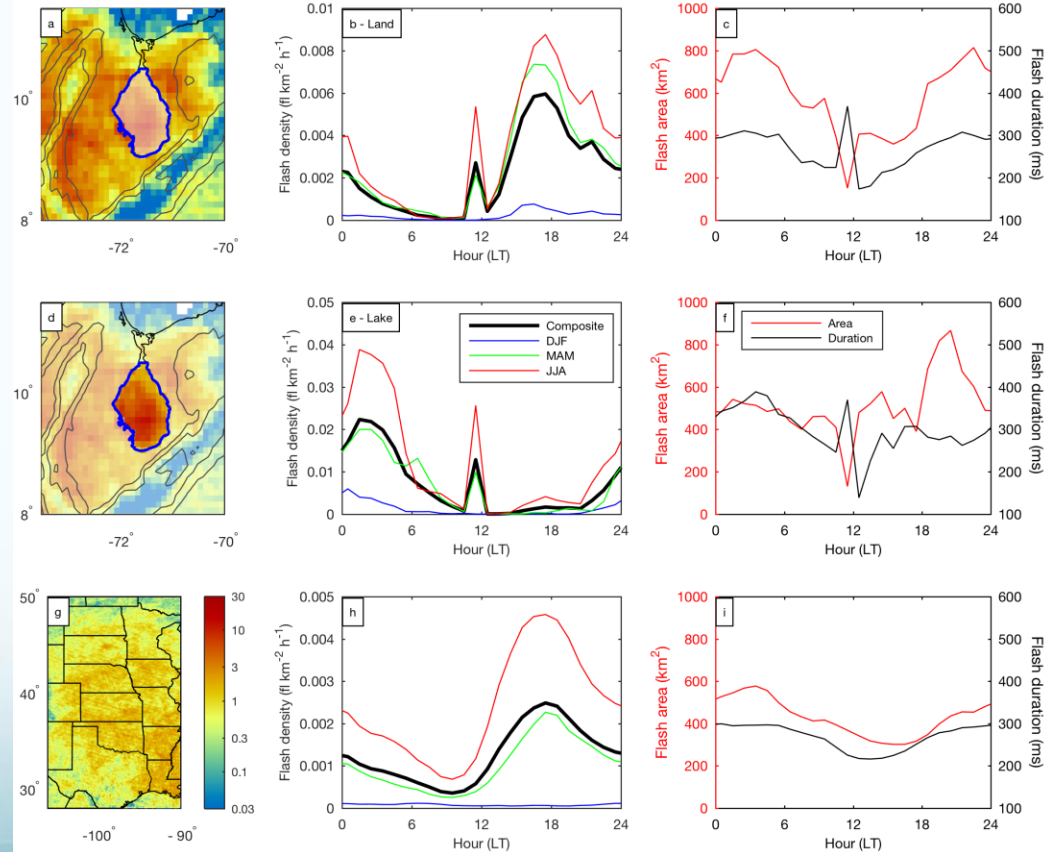

Lake Maracaibo Diurnal Cycle

- GLM flash area and duration follow similar diurnal trends (larger flashes lasted longer, with nocturnal maxima)
- Notable exception appeared near solar noon over both the lake and land
- Secondary lightning frequency spikes result from small ($< 200 \text{ km}^2$) longer duration ($> 350 \text{ ms}$) flashes, indicating effects from sun glint and blooming

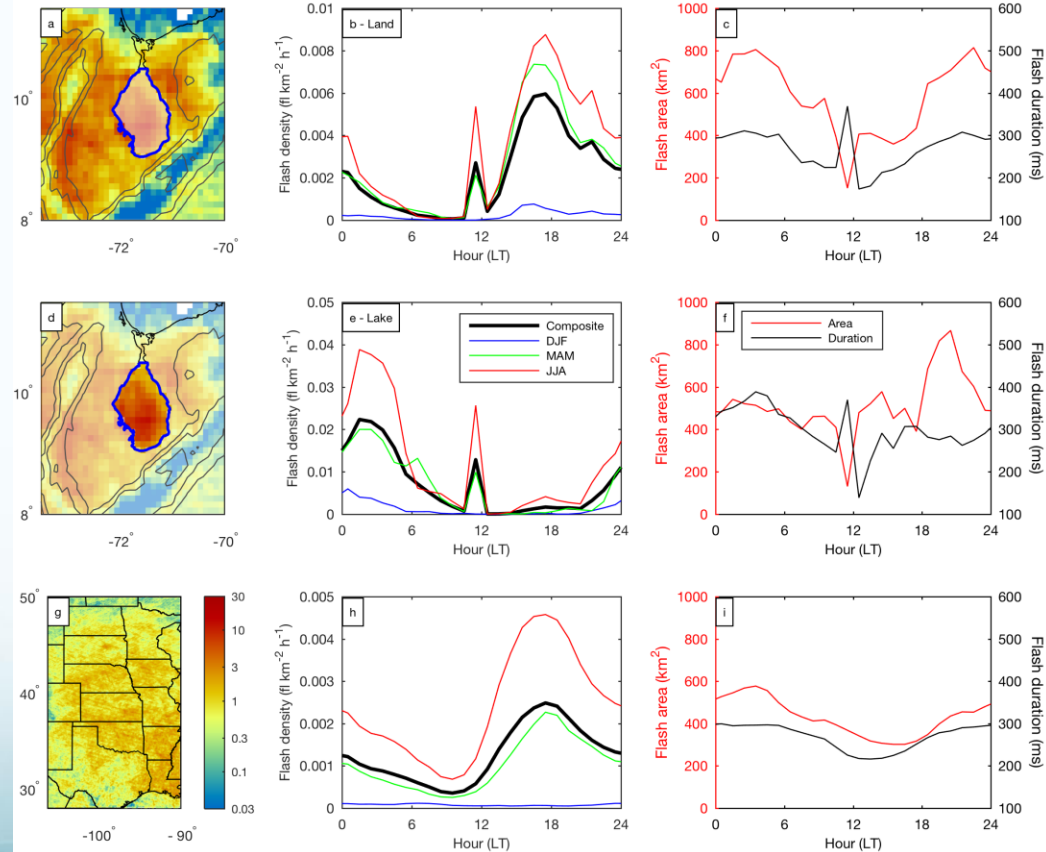

Second Recap

- **Technological advancement now allows continuous operational monitoring of lightning on time and space scales never before available**
- **The GLM enters into a golden age of lightning observations, which are presently at the beginning of a growth curve begun by other remote sensing platforms decades prior**
- **The continuous availability of spatially extensive total lightning data will spur more rapid progress toward synthesis of these observations with other meteorological datasets and forecasting tools**
- **The GLM data quality continually improves as known issues are patched and new issues are identified and addressed**
- **The GLM presents profound possibilities, with countless new applications anticipated over the coming decades**



GLM Sensitivity and False Events

- **GLM seeks to maximize detection efficiency while minimizing the false alarm rate**
- **False alarm rate is the number of false flash detections divided by the average true flash rate**
- **Each subarray is independently tuned to optimize the dynamic range and sensitivity**
- **Real Time Event Processors (RTEPS) are like lawn mowers**
 - **Blade too high = low sensitivity to dim lightning**
 - **Blade too low = flood downlink with false events**
 - **56 channels * 32 BG levels = 1792 thresholds**

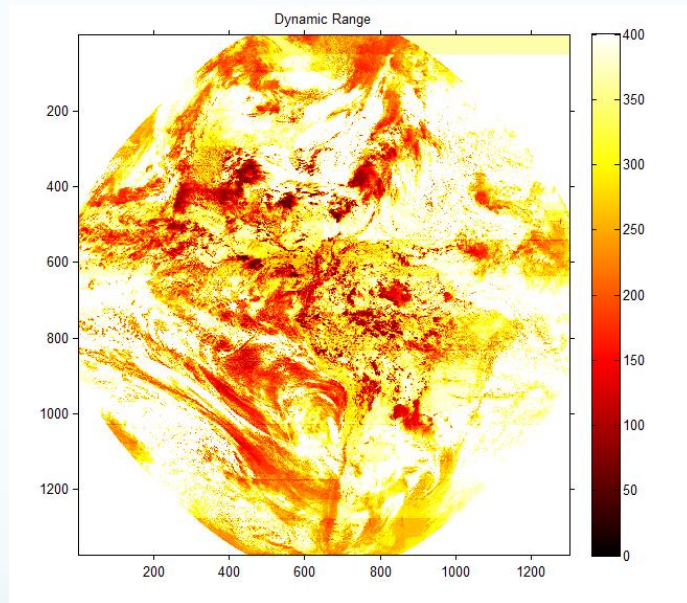

GLM is a variable pitch CCD array with 56 sub arrays and 1372 x 1300 pixels

False Events

- Platform disturbances from momentum adjust maneuvers and instrument calibration scans
- River/Lake/Ocean Glint – Calm body of water and proper sun angle (results in blooming artifact)

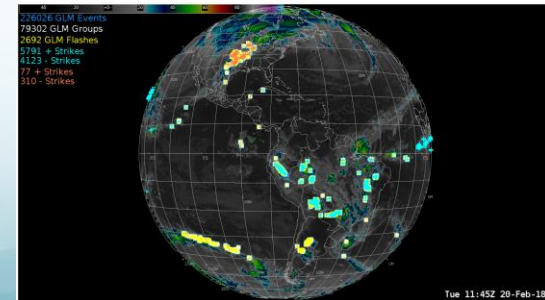
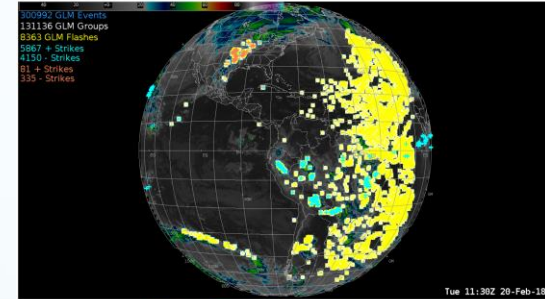
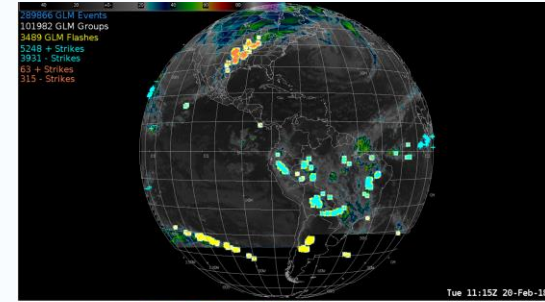
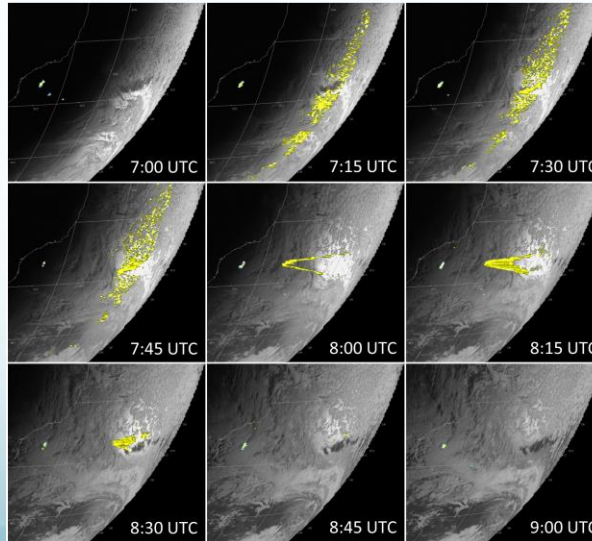
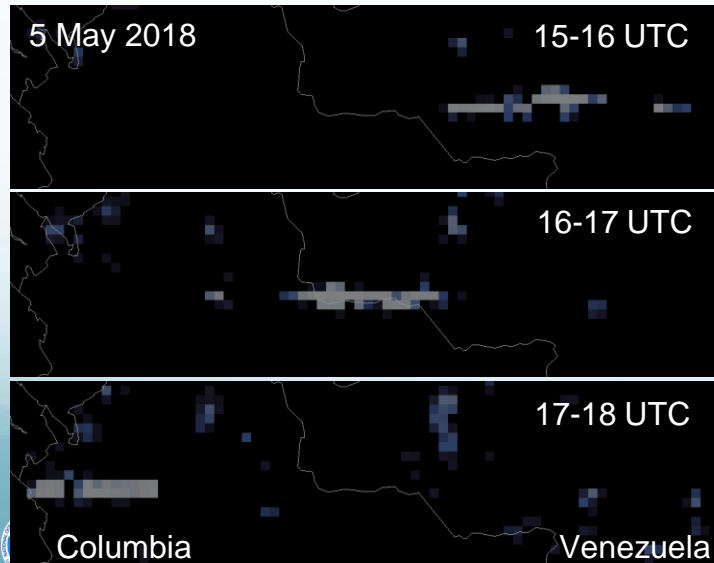

False Events

- False events at the edge of subarrays
 - Overshoot at RTEP boundaries
 - Threshold to noise ratio drops (sensitivity increases) when bright clouds persist over RTEP boundaries
- Solar intrusion during eclipse season
 - Blooming filter awaiting implementation
- The GLM is susceptible to brief outages driven by bursts of false events (short term fix implemented during December)

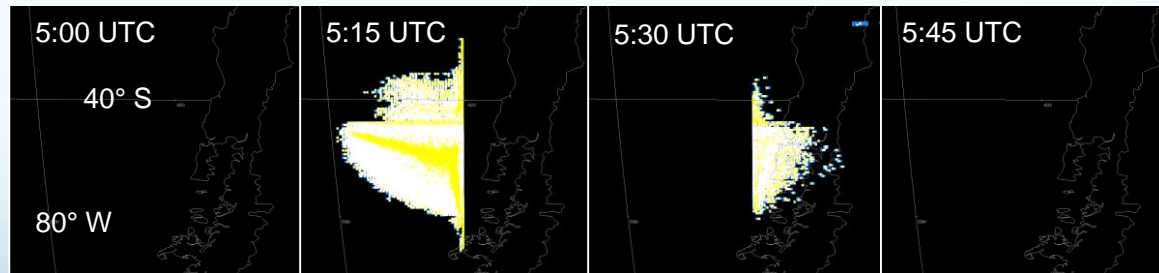
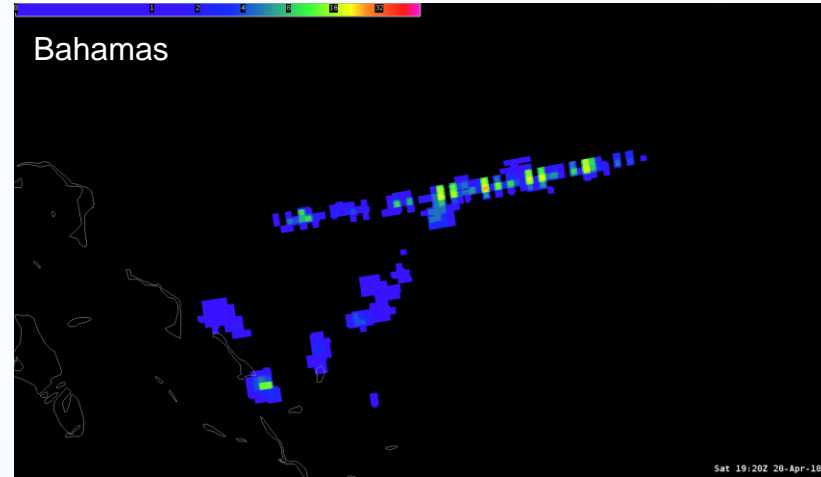

Many sources of false events (and related data outages) will be mitigated in the *longer term* by implementing a blooming filter and data quality product

Mitigation Efforts

- **The GOES ground system (GS) produces the Level 2 GLM data, GS updates are provided as periodic software patches**
- **Two most notable planned updates are the blooming filter and the L1b overshoot & second level threshold adjustments**
- **The blooming filter quenches the rapid growth of artifacts associated with both sun glint and eclipse effects**
- **The GOES team is working towards deploying a data quality product and gridded products from the GS**

GLM in the National Weather Service

- The GLM observations fundamentally differ from the ground-based lightning data most familiar to forecasters
- Initial demonstrations revealed that the early GLM tools were not well suited for real GLM data
- Motivated an intensive effort to develop a new suite of gridded GLM products tailored to NWS operations

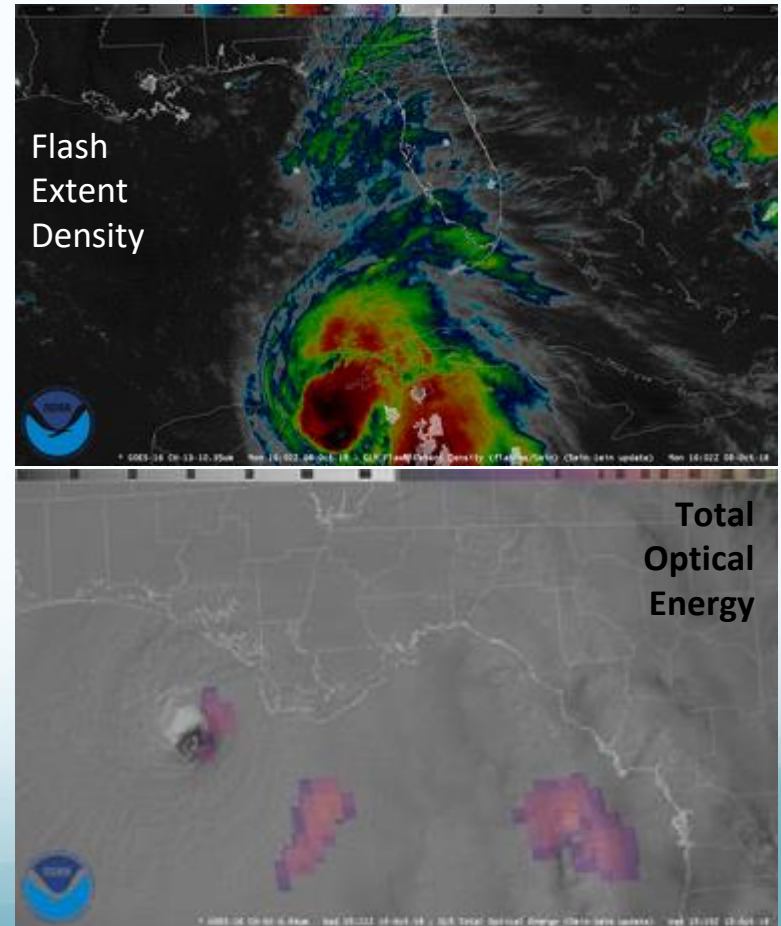

GLM Gridded Products

- **GLM Level 2 data (events, groups, and flashes) are produced as points, resulting in a loss of information concerning the spatial extent**
- **New gridded GLM product restores and disseminates the spatial footprint information while greatly reducing file size**
- **Gridded GLM products involve re-navigating the GLM event latitude / longitude to the 2×2 km Advanced Baseline Imager (ABI) fixed grid**
- **Flash extent density (FED), the number of flashes that occur within a grid cell over a given period of time, is the first NWS product**

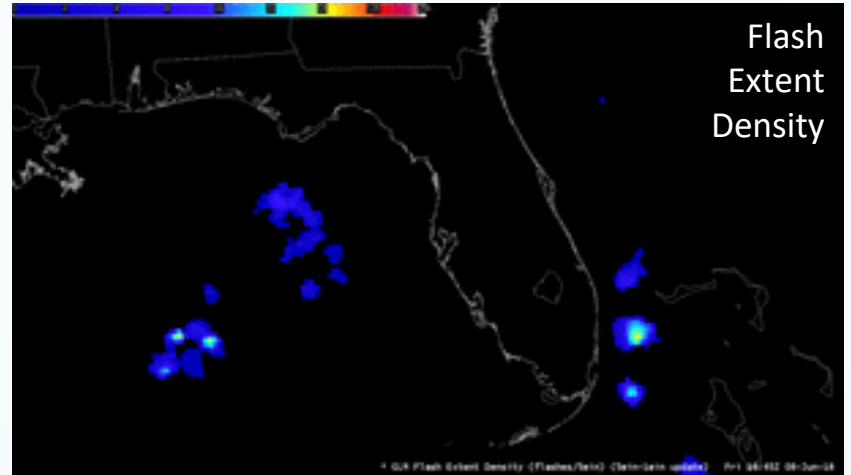

GLM Gridded Products

- These polygons are kept as is divided at the flash, group, and event levels by slicing from two points on a fixed grid
- Parent-child relationships are used to combine the event flash, group, and event levels to create the gridded products
- FED values are rounded arithmetically to the nearest integer

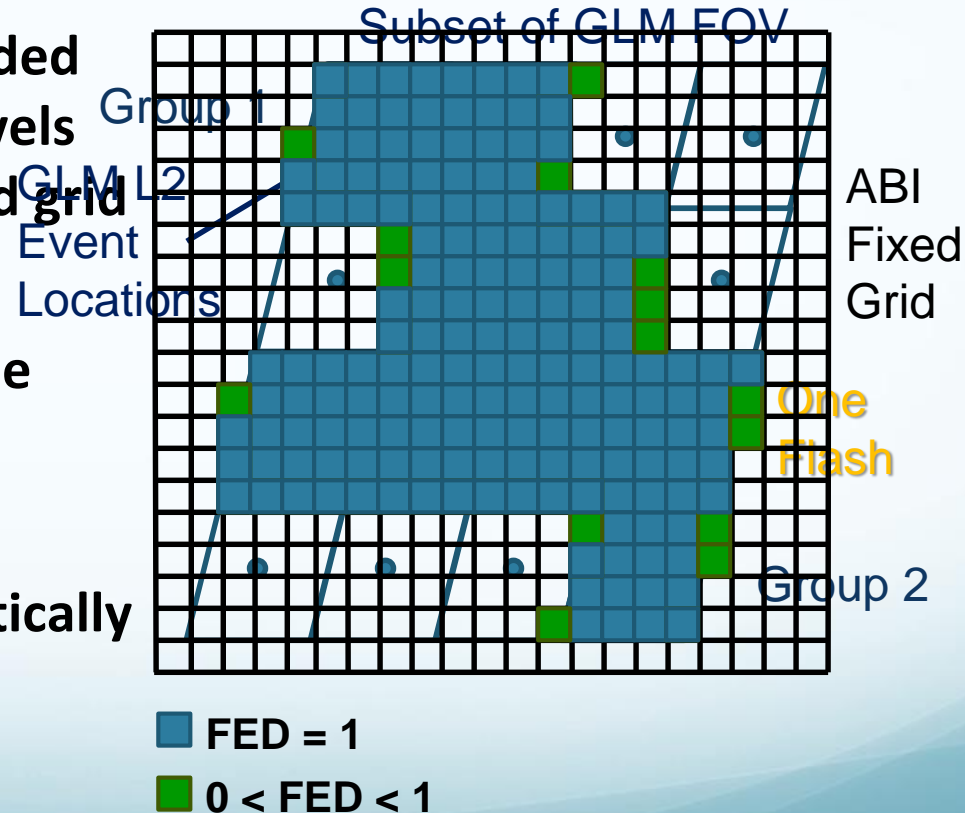

Pixel Geometry / Location Accuracy

- GLM is a variable pitch CCD array with 56 sub arrays and 1372 x 1300 pixels
- Variable pitch reduces the growth of GLM pixel footprints away from nadir, but the pixel size, shape, and orientation still vary
- Gridded GLM products have a similar parallax effect to the ABI
 - Parallax results in the gridded GLM products appearing shifted away from nadir
 - Near the limbs, where the parallax is most pronounced, GLM observations of side-cloud illumination partially counteract the parallax by shifting the GLM towards nadir

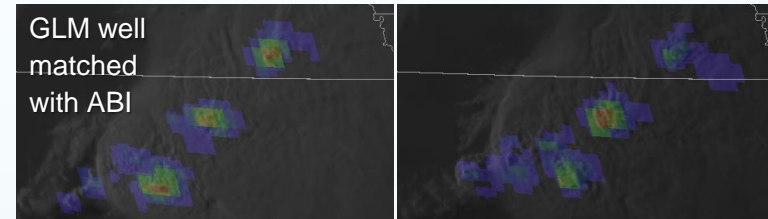
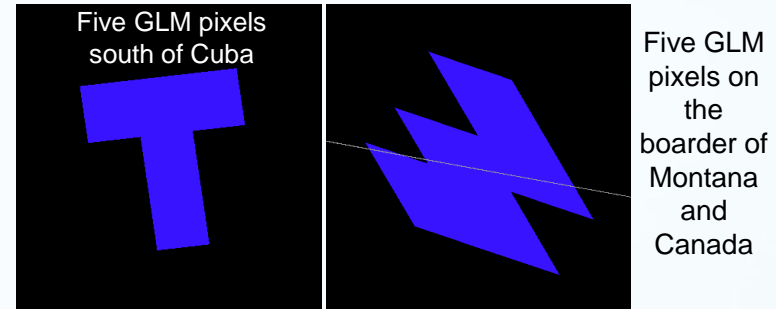

GLM, NLDN, and base reflectivity over Pennsylvania



Geospatial Considerations

- Parallax results in the gridded GLM products appearing shifted away from nadir
- Plot depicts the direction vector and peak distance offset that must be applied for the GLM to match the ground-based networks

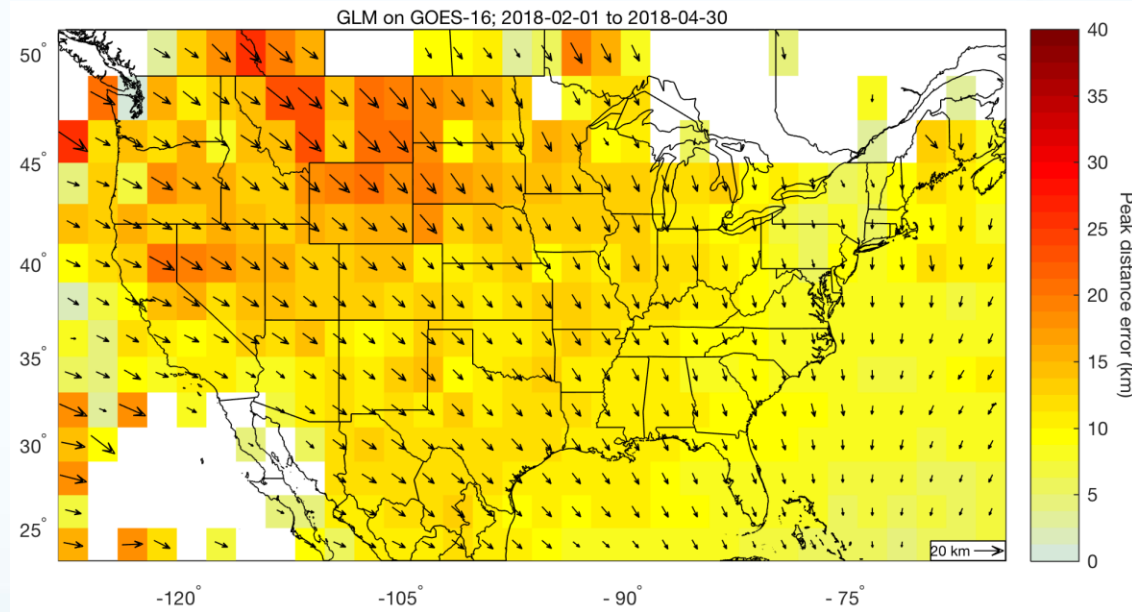

Example AWIPS Imagery

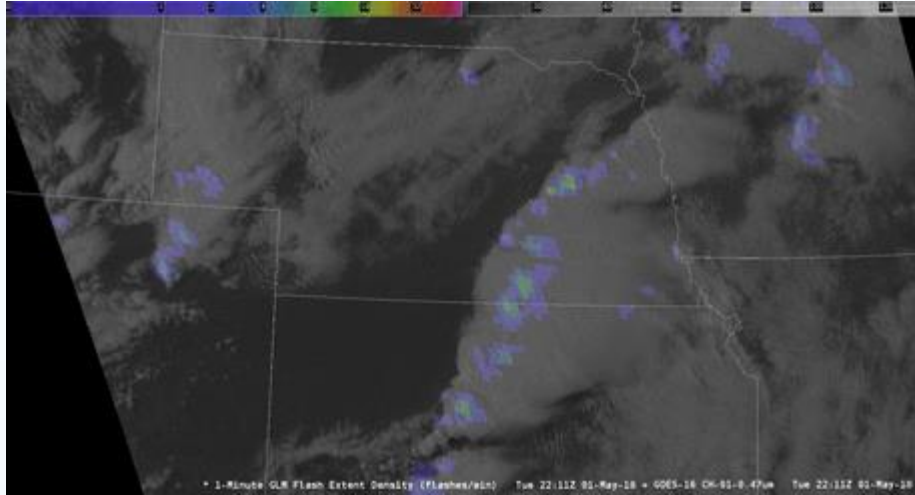

- **1-min GLM FED with 1-min mesoscale ABI visible imagery**
- **Illustrates convective processes on various scales**

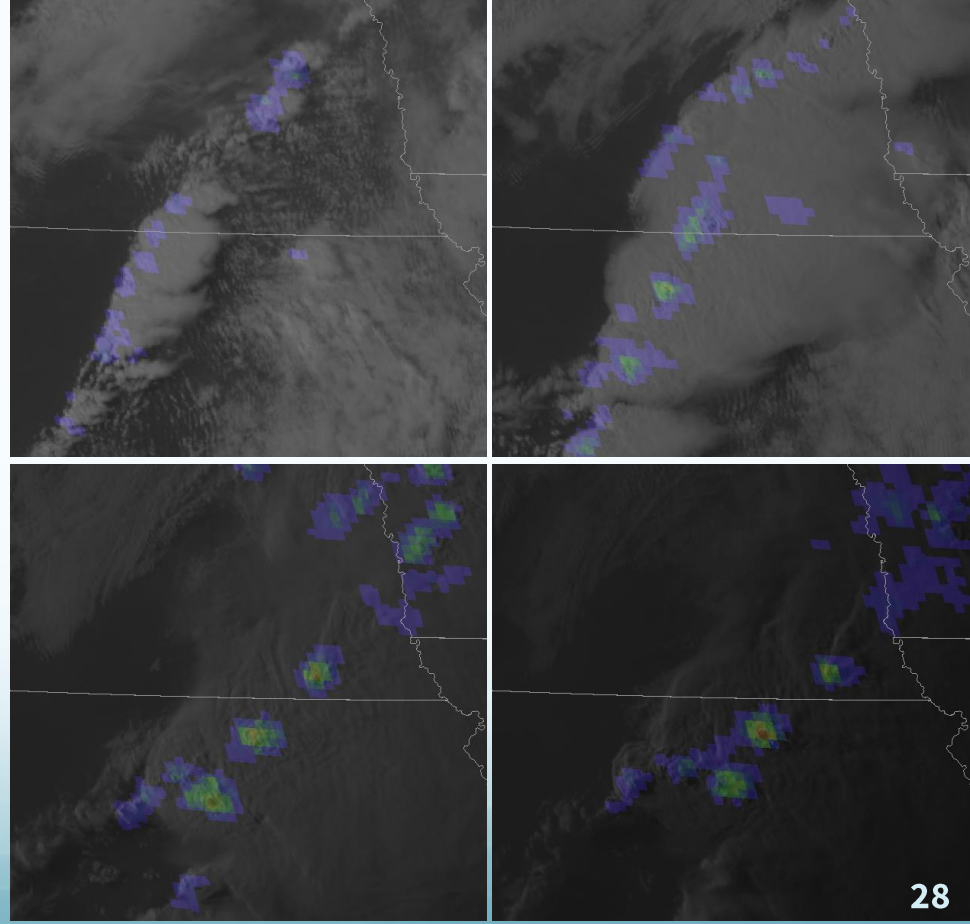

Example AWIPS Imagery

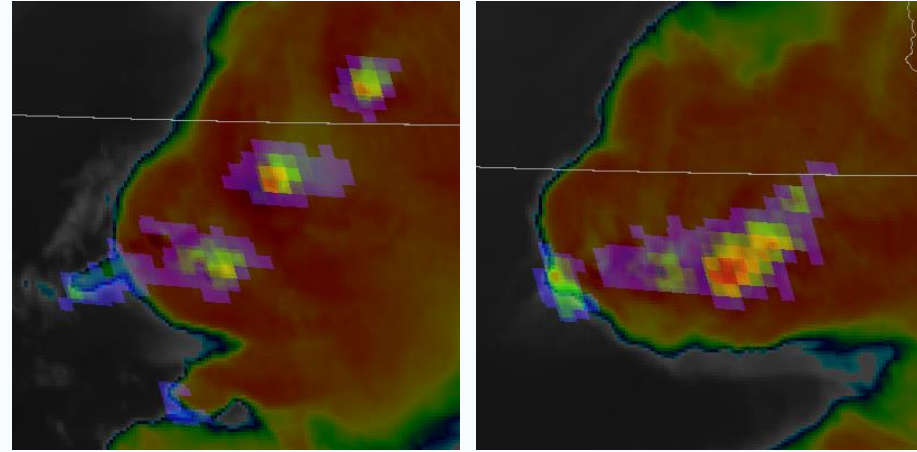
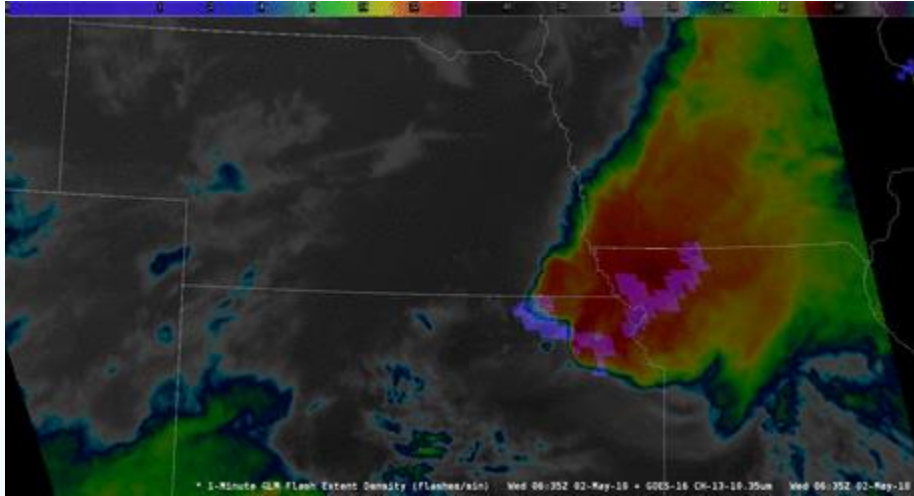

- **1-min GLM FED combined with 1-min ABI IR brightness temperatures**
- **At night, flashes are easier to detect and appear larger**
 - **Low cloud illumination**

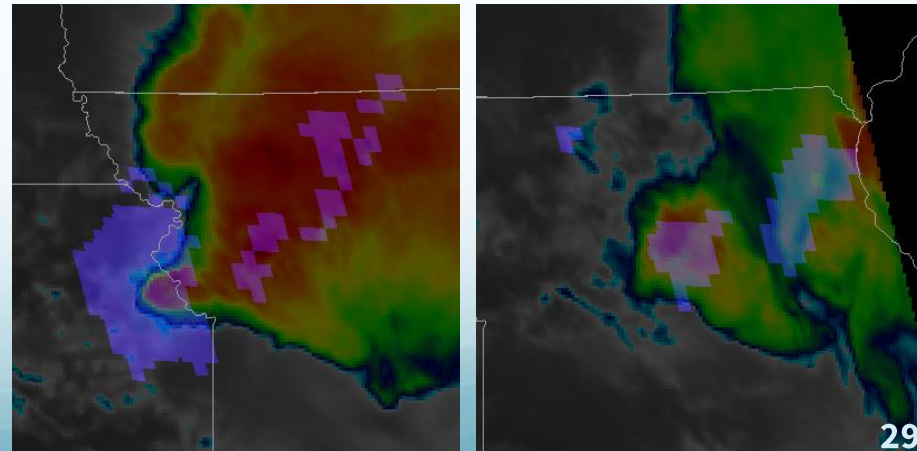

Gridded Product Path

- Gridded products presently produced and distributed via experimental channels
- Second phase will harden this interim solution
- Long-term plans envision formal NESDIS production and distribution

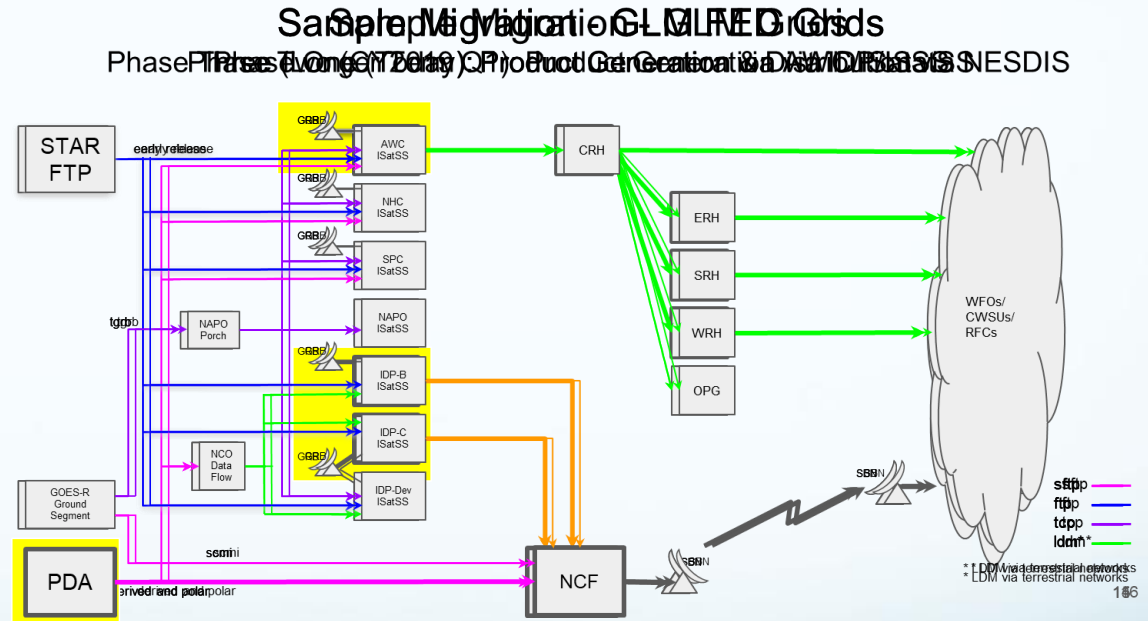

Third Recap

- **New gridded FED product rolled out during Spring/Summer 2018**
- **Gridded products created and distributed via experimental channels**
- **Restores and disseminates the spatial footprint information**
- **The FED (flash count per grid cell) is the first NWS product**
- **The GLM is re-navigated the 2×2 km ABI fixed grid**
- **Corner point lookup table and parent-child relationships are used**
- **Sliced polygons accumulated/weighed to create gridded products**
- **FED best portrays the quantity / extent of GLM flashes / events**

Additional Gridded GLM Products

- Additional gridded GLM products are being evaluated for future AWIPS deployment
- Average flash area (AFA) and total optical energy (TOE) complement FED to maximize the insights provided by the GLM
- Each gridded product can be applied to similar forecast challenges, with certain products better suited to certain applications
- AFA and TOE also provide context for understanding GLM data quality and the subtleties of space-based optical lightning observations

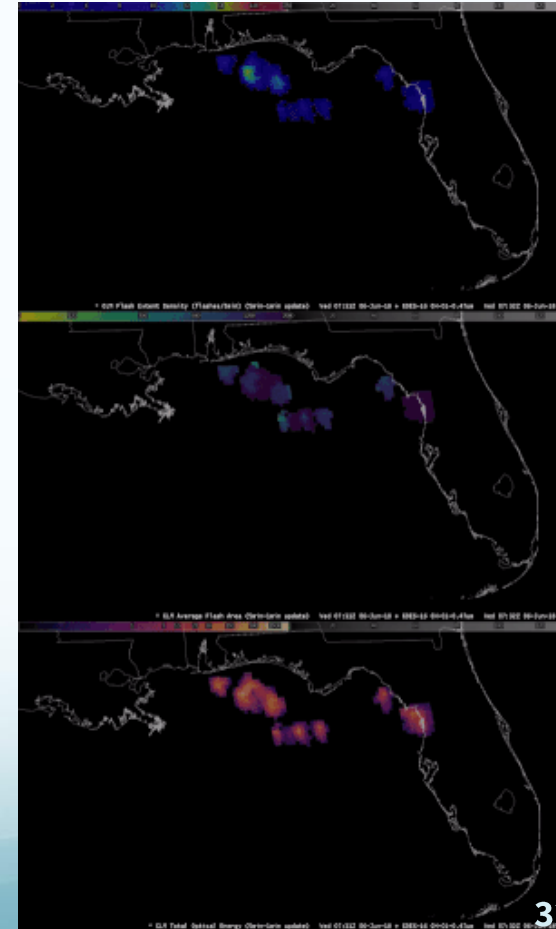

AFA and TOE Specifications

- **AFA** – average area of all flashes coincident with each 2×2 km grid cell during a specified time period
 - Units of km^2 , with values ranging from a minimum of 1 pixel or $\sim 64 \text{ km}^2$ to several thousand km^2 for regions with extensive stratiform flashes
- **TOE** – sum of all optical energy observed within each grid cell during a specified time period
 - Units of fJ, with decimal values for the dimmest flashes to $>1000 \text{ fJ}$ for regions with many bright flashes

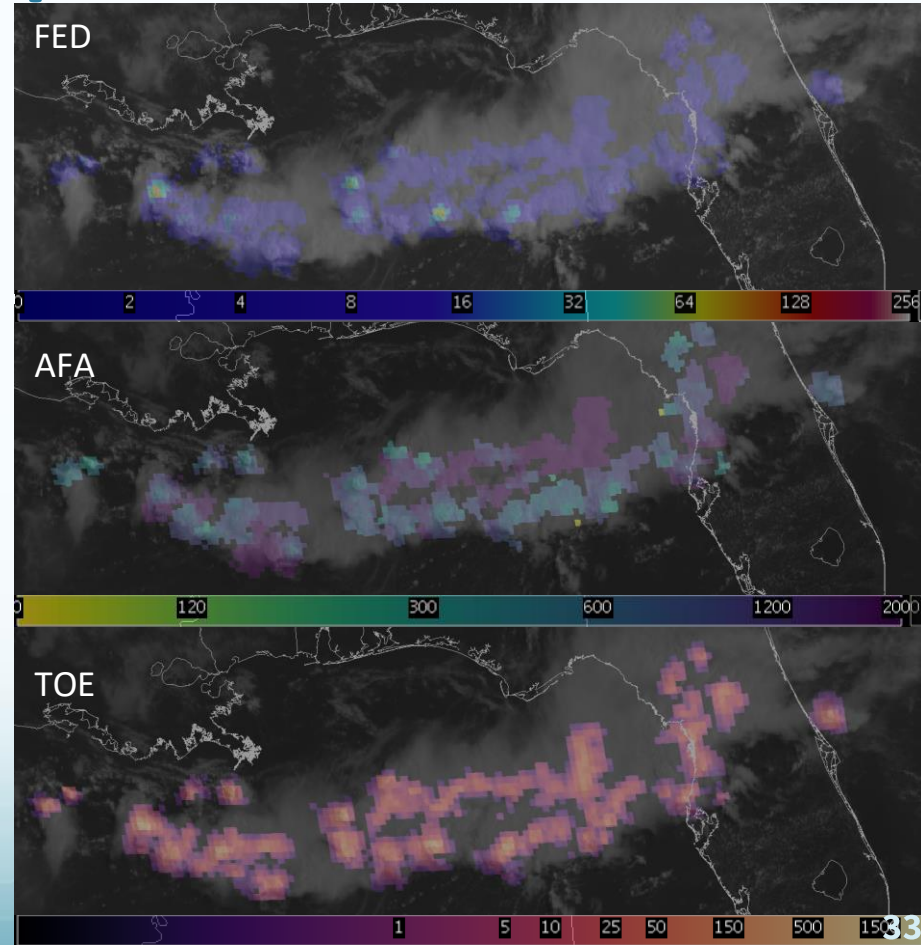

TOE and AFA Applicability

- **Bright regions in the TOE indicate...**
 - the most energetic convective cores
 - lightning channels within extensive flashes
- **AFA reveals...**
 - small flashes in new / intense convection and along the leading line
 - larger flashes in the stratiform/anvil regions and decaying storms

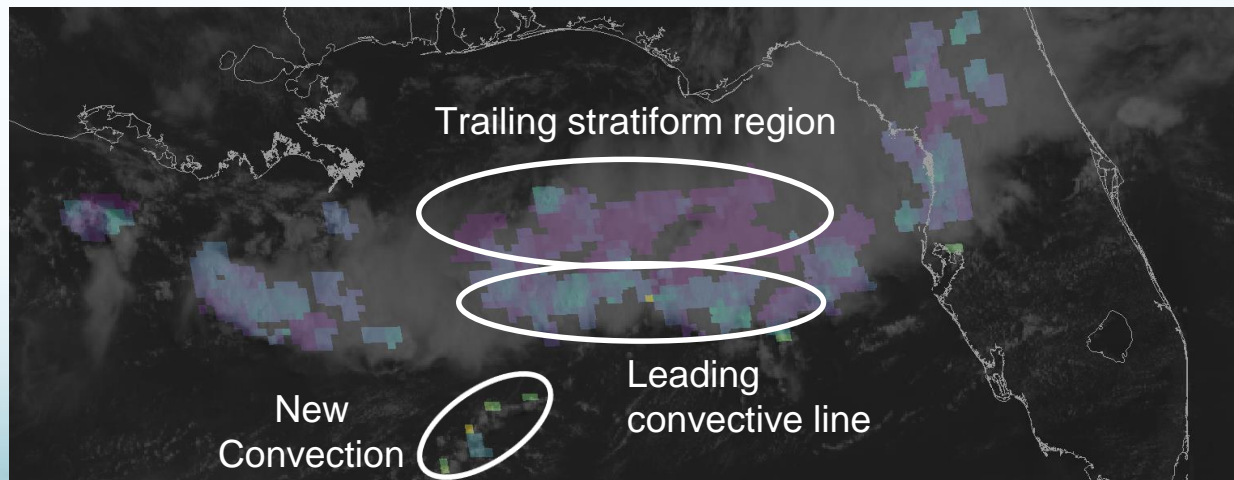
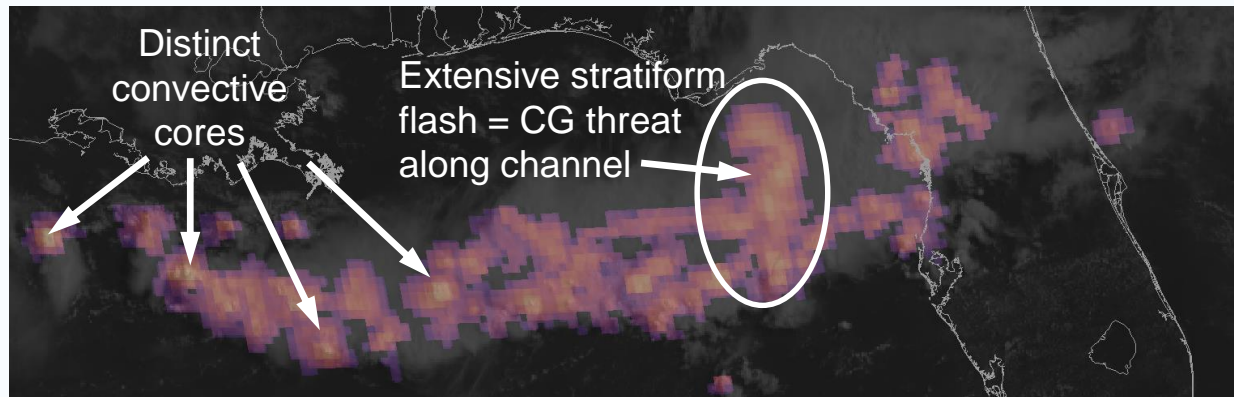

TOE and AFA Applications

- Primary TOE Applications
 - Directly represents the optical observations
 - Identify strengthening and weakening storms
 - Analyze the cloud-to-ground lightning threat
- Primary AFA Applications
 - Diagnose CI and storm growth
 - Observe the areal lightning extent
 - Monitor convective mode and storm evolution

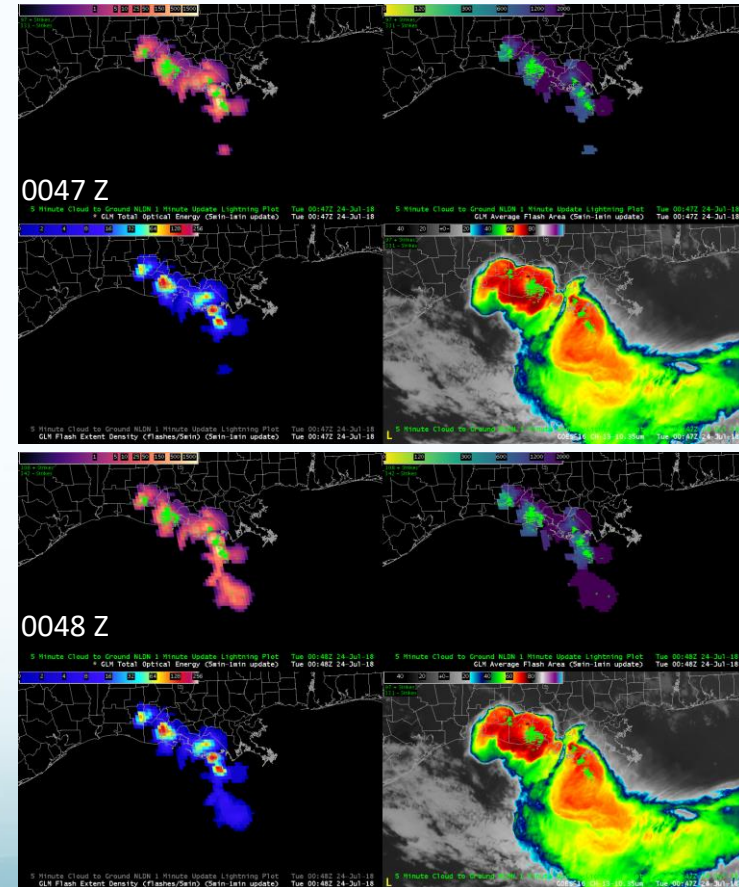
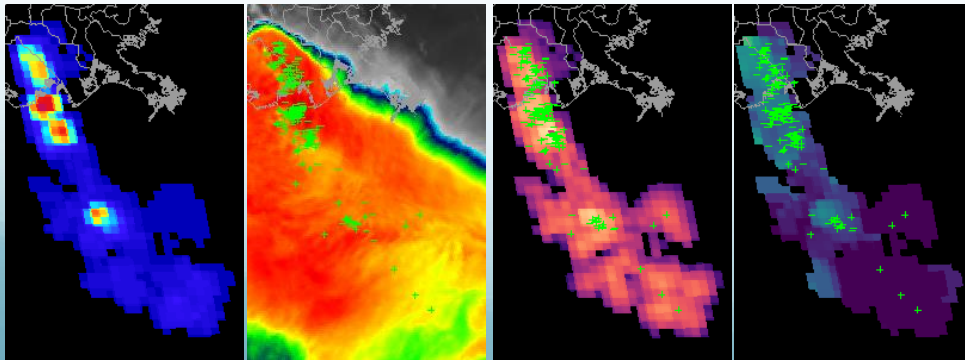

Diagnosing CI and Storm Growth

- **Detect/monitor thunderstorms**
 - **AFA color map accentuates small flashes to highlight the earliest flashes in pre-convective scenes**
 - **AFA then provides a visual que to help quantify the growth rate of individual storm cells**

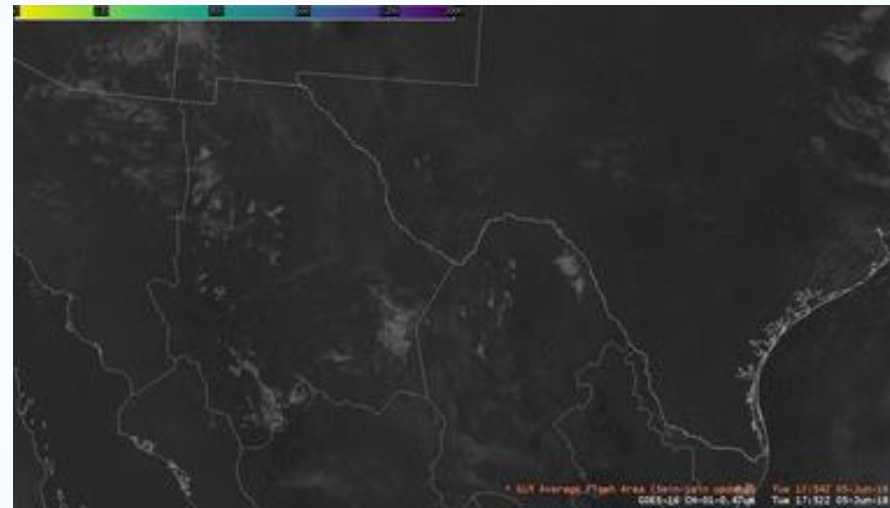

AFA 1817 UTC

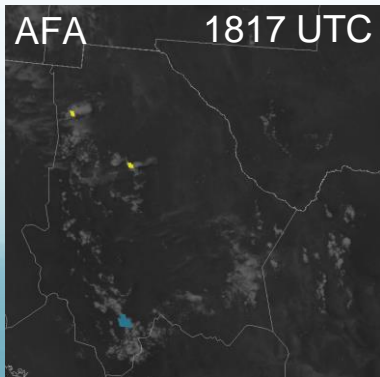

1953 UTC

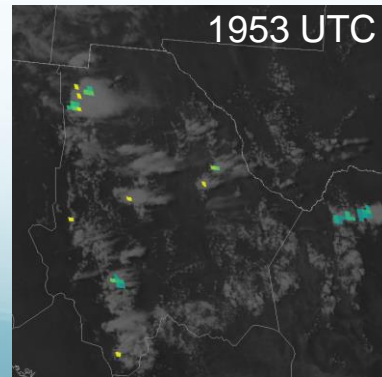

2018 UTC

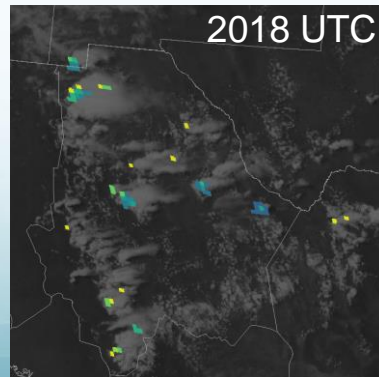

2112 UTC

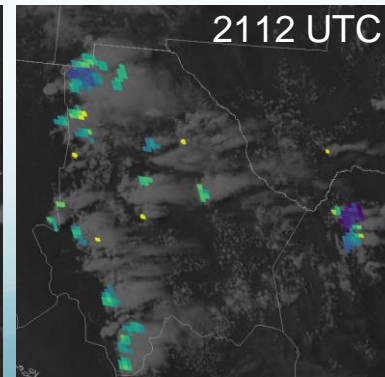

Characterizing the Convective Scene

- Differentiate anvil/stratiform flashes from newly developing convection
 - Flashes often travel long distances, connecting to remnants of earlier convection (AFA helps identify flash origin)
 - New storm cores are often first apparent in the AFA and TOE products
- Monitor storm mode and evolution
 - AFA tends to decrease as supercells intensify and increase as they dissipate
 - TOE and AFA often indicate the dominant supercell as they undergo splits

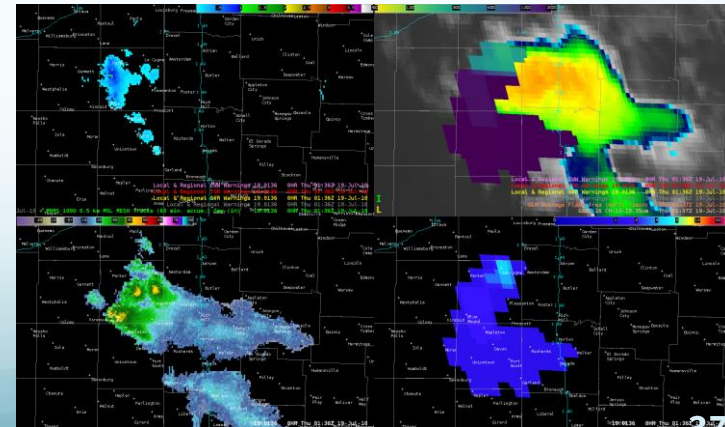
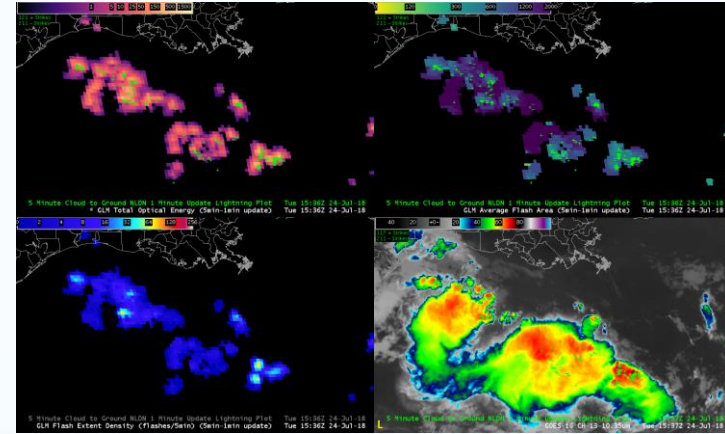

Understanding Optical Observations

- AFA and TOE help confirm false events, as well as side and low cloud illumination
- Some small flashes on cloud edges result from light escaping from below and just exceeding the detection threshold

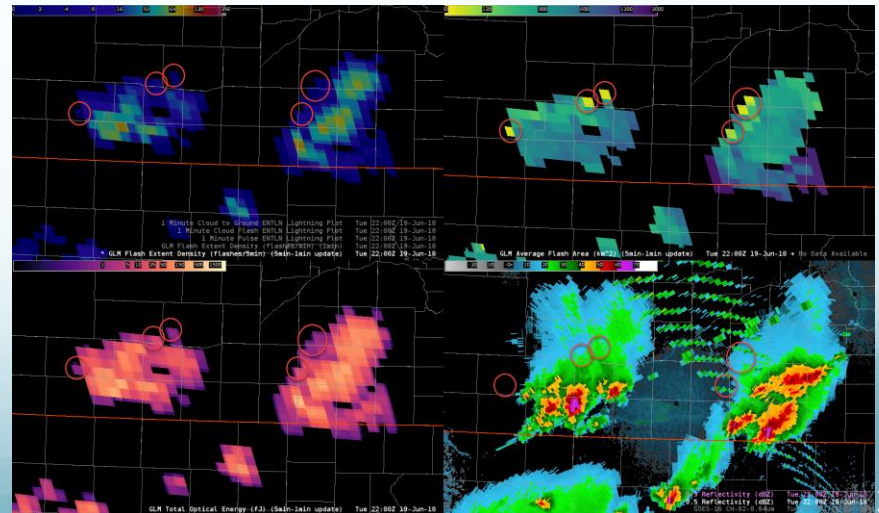
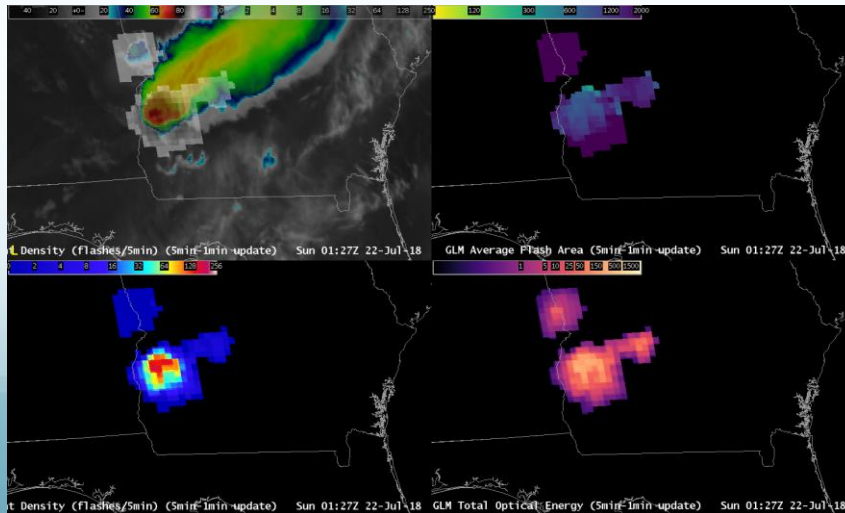
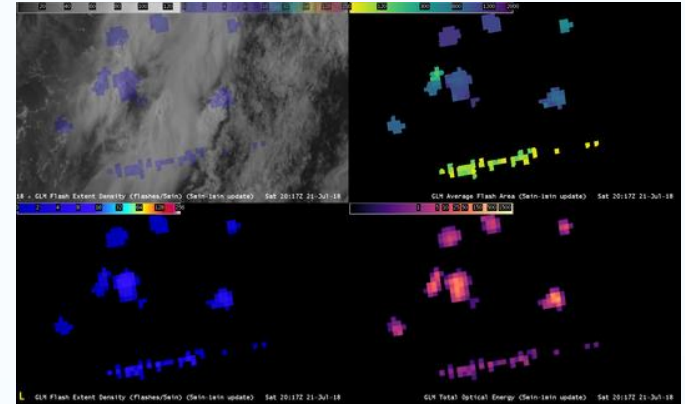

Final Recap

- **AFA and TOE complement FED to enhance the GLM insights**
- **Certain products best suited to certain applications**
- **Bright TOE indicates energetic convective cores and lightning channels**
- **Small flashes in new/intense convection and along the leading line**
- **Large flashes in the stratiform/anvil regions and decaying storms**
- **AFA accentuates small flashes and helps gauge storm growth**
- **Differentiate anvil/stratiform flashes from newly developing convection**
- **AFA and TOE help confirm false events, and side/low cloud illumination**

Path F

- *Optimizing GLM Use in AWIPS*
- Joint Technology Transfer Initiative (JTTI) project selected late in the funding cycle
- Leveraged GOES-R science funds to accomplish the first year (i.e., gridded product development/distribution)
- The planned GLM tool moves beyond individual lightning products to introduce a new technique with a broad array of operational applications

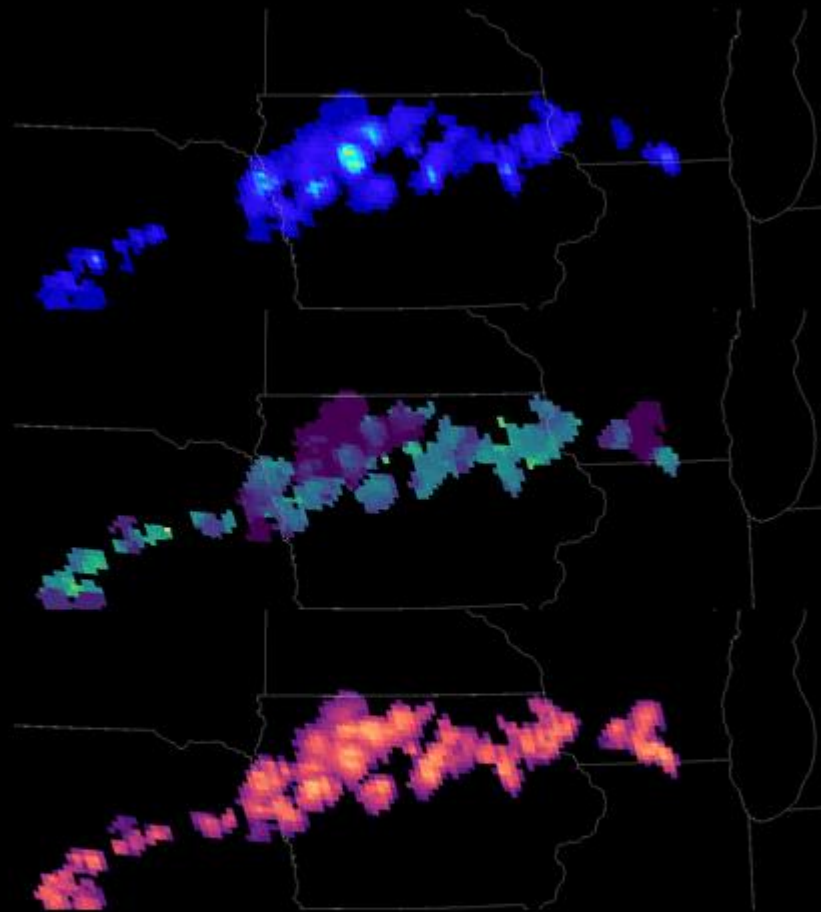

Any Questions?

- Thank you for attending!
- The GLM page on the NWS Virtual Lab supports GLM implementation and training

<https://vlab.ncep.noaa.gov/web/geostationary-lightning-mapper>

- Near real time GLM and ABI imagery

<http://lightning.umd.edu/Apps/GoesCesium/>

- Routinely created GLM videos

<https://www.dropbox.com/sh/uamym2vtztxe7g9/AABhm0tnO0r0DNUZJIBUwPXAA?dl=0>

